

Linear

TIMI Glow R014

Fixture Guide

KKDC

Indoor | Surface | Output up to 697lm/m (213lm/ft)

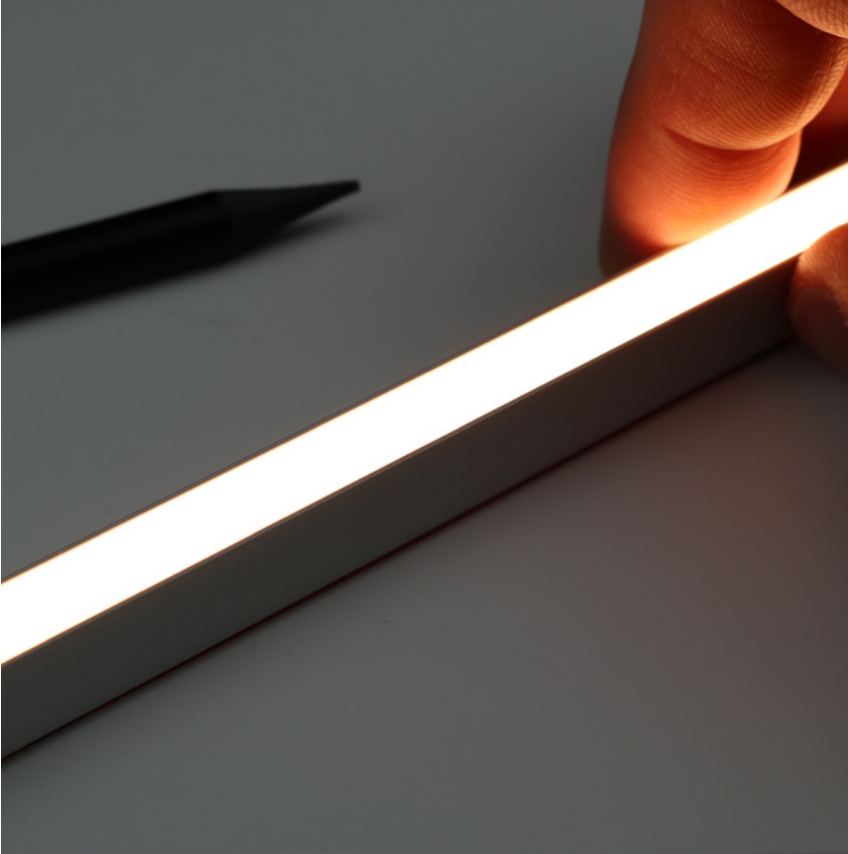

Key applications

- ✓ Architectural detail
- ✓ Cabinet & furniture
- ✓ Cove lighting
- ✓ Direct lighting
- ✓ Interior
- ✓ Mirror back lighting
- ✓ Retail display
- ✓ Shelving display

Key features

- ✓ Custom lengths
- ✓ Constant Voltage (CV)
- ✓ Diffusion: homogenous
- ✓ Direct view
- ✓ Extensive CCT range
- ✓ Illuminated ends
- ✓ IP40 dry area
- ✓ IP44 moisture resistant
- ✓ Thin light line

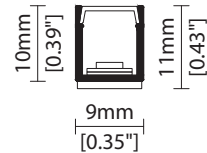

MOUNTING METHODS



KKCP-22 Lock Clip

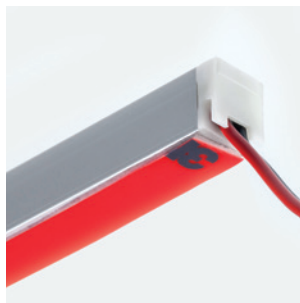

3M tape mounting



Dual cable exit design

Linear

TIMI Glow R014

Specification sheet



Dimensions	H10/W9/L91.4-2008mm (H0.39/W0.35/L3.60-79.06in)
PCB Cut-point	41.7mm increment/2000mm max (1.64in increment/78.74in max)
LED Pitch	6.95mm-144LED/m (0.27in - 44LED/ft)
Chip	s-line k-line
Cover/Optics	Diffused (110°)
CCT	s-line: 1900K/2100K/2300K/2500K/2700K/3000K/3500K/4000K/5000K Single colours: Red/Green/Blue/Orange/Amber k-line: 1900K/2100K/2300K/2500K/2700K/3000K/3500K/4000K/5000K
LED binning	s-line: 2-step MacAdam ellipse k-line: 3-step MacAdam ellipse
CRI	≥ 92
Lifetime	50,000 hours @ 25°C (50,000 hours @ 77°F)
Operating temp	T _a = -25 to 40°C (T _c max = 74.6°C) T _a = -13 to 104°F (T _c max = 166 °F)
IP Rating	IP40/IP44
Finish	Silver anodised
Mounting	Surface mounting via 3M tape or clips
Power feed	Hardwire tails or male/female connectors
Control	0-10V/1-10V/DMX/DALI



LED Grading Key

Exclusive Grade

s-line*
2-step CCT range

*KKDC tuned
CCT range

Base Grade

k-line
3-step commercial range
Energy Star CCTs

Power consumption	Supply voltage	Supply current
14W/m (4.27W/ft)	24V DC	0.58A/m (0.18A/ft)

Performance Data (3000K)

	R1	R2	R3	R4	R5	R6	R7	R8	R9	R10	R11	R12	R13	R14		
k-line	93	97	98	91	92	94	92	83	64	92	91	75	94	98		
	Diffused												CRI	R9	Rf	Rg
s-line	697lm/m (213lm/ft) 49.8lm/W												93	65	-	-
k-line	658lm/m (201lm/ft) 47lm/W												92	64	-	-

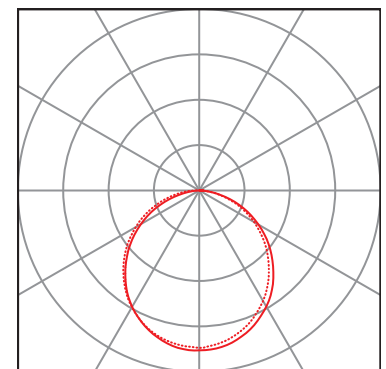
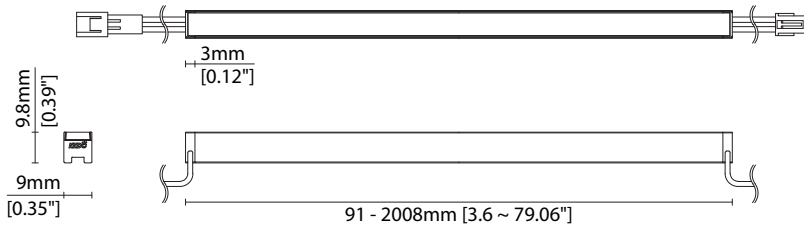

Data derived from independent UKAS/IESNA LM-79-08 accredited testing of production samples.

TIMI Glow R014

Code Table



FIXTURE

Model	Finish	Cover ¹	Grade ²	LED	Colour (CCT)	Length Availability ³	IP	Cable Length	Power Feed ⁴	Input											
TIMI Glow	TG	Silver Anodised	SA	Diffused	C	<div style="display: flex; align-items: center;"> <div style="background-color: #e91e63; color: white; padding: 2px 5px; margin-right: 5px;">s</div> <div style="font-size: 10px; margin-right: 5px;">s</div> </div> <div style="display: flex; align-items: center;"> <div style="background-color: #ff9800; color: white; padding: 2px 5px; margin-right: 5px;">k</div> <div style="font-size: 10px; margin-right: 5px;">k</div> </div>	R014	R014	1900K	19	m	91.4-2008mm 41.7mm increments	IP40	40	50mm (1.97in)	0050	Single no sheath tail	S00X	DC 24V	g	
									2100K	21											
									2300K	23	i	3.60-79.06in 1.64in increments	(Specify length code OR total run length)	IP44	44	300mm (11.81in)	0300	Double no sheath tail			D00X
									2500K	25											
									2700K	27											
									3000K	30											
									3500K	35											
									4000K	40											
									5000K	50											
									RED	RED	s-only										
									GREEN	GRN											
									BLUE	BLU											
									ORANGE	ORN											
AMBER	AMB																				

¹ Refer to **Cover/Lens Options** on **Options** pages

² Refer to **LED Grading /Key** on **Specification sheet** page

³ Refer to **Length Availability List** or enter total run length instead of length code

⁴ Refer to **Power Feed Options** on **Options** pages

Code Example:

TG	-	SA	-	C	-	k	-	R014	-	35	-	m	-	508	-	40	-	0300	-	D20X	-	g
TIMI Glow		Silver Anodised		Diffused		<div style="background-color: #ff9800; color: white; padding: 2px 5px;">k</div>		R014		3500K		508mm		IP40		300mm/11.81"		Double no sheath IP20 connector		DC 24V		

ACCESSORIES

Mounting Accessories

KKCP-22 Lock Clip (1no.)

* Refer to **Mounting accessories** on **Accessories** pages

Connection Accessories

KKCN-01 2 PIN male & female 50mm (1.97in) pair

KKCN-03 2 PIN male & female 300mm (11.81in) pair

KKCN-06 2 PIN 300mm (11.81in) extension lead

* Refer to **Power feed** on **Accessories** pages

PSU/Driver

0-10V/1-10V/DALI/DMX

* Refer to **Driver/PSU Options** page for details or provide requirement and KKDC to offer the suitable option

LED ENGINE VARIANTS (LED STRIP TYPE)

Colour	LED	Lumen/m	Lumen/ft	W/m	W/ft	Spec Doc	Length	Increment
Single CCT	R014	697	213	14	4.27	TIMI Glow R014	91.4-2008mm (3.60-79.06in)	41.7mm (1.64in)
	R020	912	278	20	6.09	TIMI Glow R020	91.4-2008mm (3.60-79.06in)	41.7mm (1.64in)
	A010	700	213	10	3.05	TIMI Glow A010	85-2008mm (3.34-79.06in)	38.46mm (1.51in)
	A020	1400	427	20	6.10	TIMI Glow A020	85-2008mm (3.34-79.06in)	38.46mm (1.51in)

* Performance data: A-line, 3000K, diffused cover

Linear

TIMI Glow R014

Length Availability List



Length Code		Fixture Length ¹		LED Strip ²		End Cap Dimension ³		Wattage (W)	Output (lm)
Metric	Imperial(US)	Metric	Imperial(US)	Metric	Imperial(US)	Metric	Imperial(US)		3000K (Test Data)
m0091	i0004	91mm	3.60in	83mm	3.28in	6mm	0.24in	1.17	55
m0133	i0005	133mm	5.24in	125mm	4.92in	6mm	0.24in	1.75	82
m0175	i0007	175mm	6.88in	167mm	6.56in	6mm	0.24in	2.33	110
m0216	i0009	216mm	8.52in	208mm	8.20in	6mm	0.24in	2.92	137
m0258	i0010	258mm	10.16in	250mm	9.84in	6mm	0.24in	3.50	164
m0300	i0012	300mm	11.80in	292mm	11.48in	6mm	0.24in	4.08	192
m0341	i0013	341mm	13.44in	333mm	13.12in	6mm	0.24in	4.67	219
m0383	i0015	383mm	15.08in	375mm	14.76in	6mm	0.24in	5.25	247
m0425	i0017	425mm	16.72in	417mm	16.40in	6mm	0.24in	5.83	274
m0466	i0018	466mm	18.36in	458mm	18.04in	6mm	0.24in	6.42	302
m0508	i0020	508mm	20.00in	500mm	19.69in	6mm	0.24in	7.00	329
m0550	i0022	550mm	21.64in	542mm	21.33in	6mm	0.24in	7.58	356
m0591	i0023	591mm	23.28in	583mm	22.97in	6mm	0.24in	8.17	384
m0633	i0025	633mm	24.92in	625mm	24.61in	6mm	0.24in	8.75	411
m0675	i0027	675mm	26.56in	667mm	26.25in	6mm	0.24in	9.33	439
m0716	i0028	716mm	28.20in	708mm	27.89in	6mm	0.24in	9.92	466
m0758	i0030	758mm	29.84in	750mm	29.53in	6mm	0.24in	10.50	493
m0800	i0031	800mm	31.48in	792mm	31.17in	6mm	0.24in	11.08	521
m0841	i0033	841mm	33.12in	833mm	32.81in	6mm	0.24in	11.67	548
m0883	i0035	883mm	34.76in	875mm	34.45in	6mm	0.24in	12.25	576
m0925	i0036	925mm	36.40in	917mm	36.09in	6mm	0.24in	12.83	603
m0966	i0038	966mm	38.04in	958mm	37.73in	6mm	0.24in	13.42	631
m1008	i0040	1008mm	39.69in	1000mm	39.37in	6mm	0.24in	14.00	658
m1050	i0041	1050mm	41.33in	1042mm	41.01in	6mm	0.24in	14.58	685
m1091	i0043	1091mm	42.97in	1083mm	42.65in	6mm	0.24in	15.17	713
m1133	i0045	1133mm	44.61in	1125mm	44.29in	6mm	0.24in	15.75	740
m1175	i0046	1175mm	46.25in	1167mm	45.93in	6mm	0.24in	16.33	768
m1216	i0048	1216mm	47.89in	1208mm	47.57in	6mm	0.24in	16.92	795
m1258	i0050	1258mm	49.53in	1250mm	49.21in	6mm	0.24in	17.50	822
m1300	i0051	1300mm	51.17in	1292mm	50.85in	6mm	0.24in	18.08	850
m1341	i0053	1341mm	52.81in	1333mm	52.49in	6mm	0.24in	18.67	877
m1383	i0054	1383mm	54.45in	1375mm	54.13in	6mm	0.24in	19.25	905
m1425	i0056	1425mm	56.09in	1417mm	55.77in	6mm	0.24in	19.83	932
m1466	i0058	1466mm	57.73in	1458mm	57.41in	6mm	0.24in	20.42	960
m1508	i0059	1508mm	59.37in	1500mm	59.06in	6mm	0.24in	21.00	987
m1550	i0061	1550mm	61.01in	1542mm	60.70in	6mm	0.24in	21.58	1014
m1591	i0063	1591mm	62.65in	1583mm	62.34in	6mm	0.24in	22.17	1042
m1633	i0064	1633mm	64.29in	1625mm	63.98in	6mm	0.24in	22.75	1069
m1675	i0066	1675mm	65.93in	1667mm	65.62in	6mm	0.24in	23.33	1097
m1716	i0068	1716mm	67.57in	1708mm	67.26in	6mm	0.24in	23.92	1124
m1758	i0069	1758mm	69.21in	1750mm	68.90in	6mm	0.24in	24.50	1151
m1800	i0071	1800mm	70.85in	1792mm	70.54in	6mm	0.24in	25.08	1179
m1841	i0072	1841mm	72.49in	1833mm	72.18in	6mm	0.24in	25.67	1206

TIMI Glow R014

Length Availability List



Length Code		Fixture Length ¹		LED Strip ²		End Cap Dimension ³		Wattage (W)	Output (lm)
Metric	Imperial(US)	Metric	Imperial(US)	Metric	Imperial(US)	Metric	Imperial(US)		3000K (Test Data)
m1883	i0074	1883mm	74.13in	1875mm	73.82in	6mm	0.24in	26.25	1234
m1925	i0076	1925mm	75.77in	1917mm	75.46in	6mm	0.24in	26.83	1261
m1966	i0077	1966mm	77.41in	1958mm	77.10in	6mm	0.24in	27.42	1289
m2008	i0079	2008mm	79.06in	2000mm	78.74in	6mm	0.24in	28.00	1316

¹ Actual total overall length of light fixture (LED strip + end caps + void/wire hole)

² Actual length of PCB strip

³ Actual length of 2x end caps

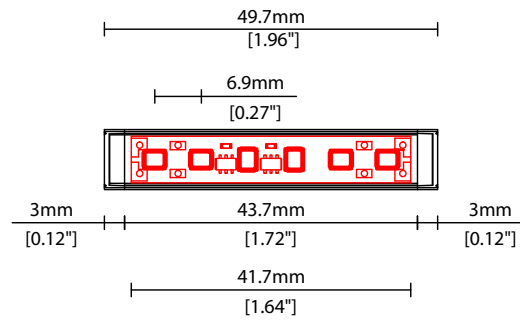



TIMI Glow R014

Options



COVER/LENS OPTIONS

* Options are an integral part of the fixture ordering codes. Please refer to **Code Table** pages.

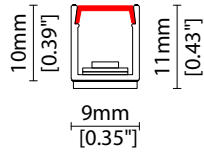

C Diffused cover
W9/H10mm (W0.35/H0.39")

POWER FEED OPTIONS

0050 S20X 50mm (1.97") Single no sheath IP20 connector

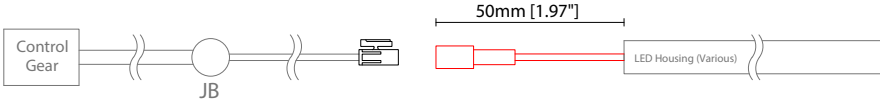

0050 D20X 50mm (1.97") Double no sheath IP20 connector

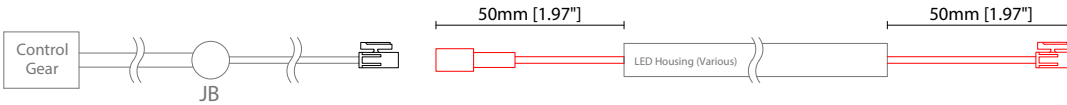

0300 S00X 300mm (11.81") Single no sheath tail

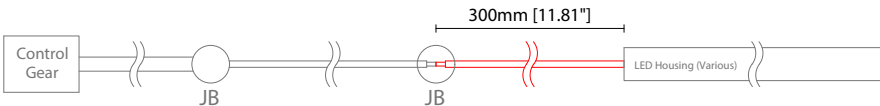

0300 D00X 300mm (11.81") Double no sheath tail

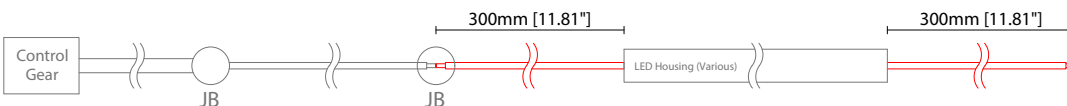

0300 S20X 300mm (11.81") Single no sheath IP20 connector

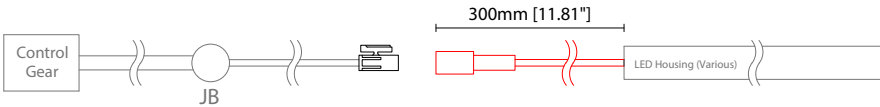

0300 D20X 300mm (11.81") Double no sheath IP20 connector

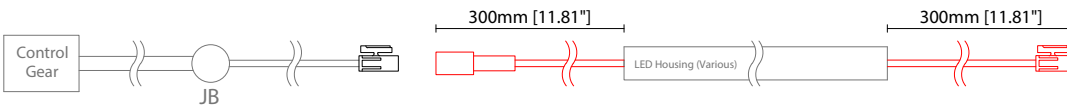

2 Pin Female Connector

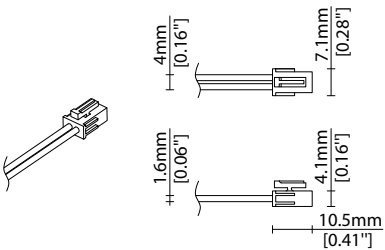

2 Pin Male Connector

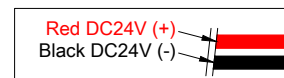
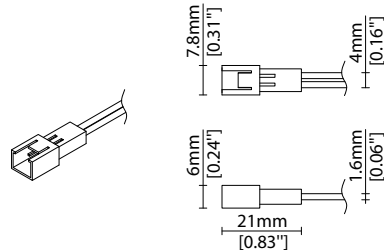

Key

- Control Gear Power supply, sub-controllers & control systems
- JB Junction box / cable connection

MOUNTING ACCESSORIES

Note: Accessories are to be ordered separately with corresponding code shown below.

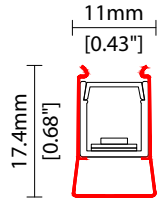

KKCP-22 (1no.)

Lock Clip (allow 3 per metre/40in)
S/Steel finish

L25/W11/H17.4mm
(L0.98/W0.43/H0.68")

POWER FEED

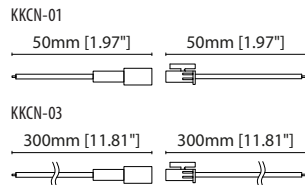
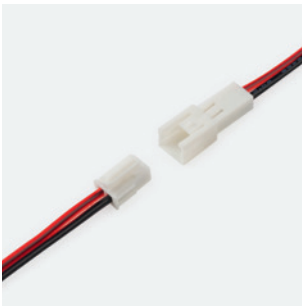

KKCN-01 50mm (1.97in) pair

KKCN-03 300mm (11.81in) pair

2 PIN male + female connector set

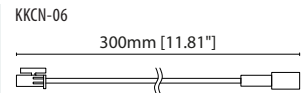

KKCN-06

2 PIN 300mm (11.81in) extension
lead

KKDC CONTROL



IP20
Plastic housing
L170/W59/H29mm
(L6.69/W2.32/H1.14in)

KKDM-06 1-10V
visDIM dimmable sub-controller
(4 x 8A max @ 12-36V)



IP20
Plastic housing
L170/W53.4/H28mm
(L6.69/W2.10/H1.10in)

KKSC-05 DMX
visDIM dimmable sub-controller
(4 x 5A max @ 12-36V)



IP20
Plastic housing
L170/W59/H29mm
(L6.69/W2.32/H1.14in)

KKDL-02 DALI
visDIM dimmable sub-controller
(4 x 8A max @ 12-36V)



IP20
Plastic housing
L166/W53.4/H23mm
(L6.54/W2.10/H0.91in)

KKDL-03 DALI
visDIM dimmable sub-controller
(4 x 5A max @ 12-36V)



IP20
Plastic housing
L170/W53.4/H28mm
(L6.69/W2.10/H1.10in)

KKDL-04 DALI-2
visDIM dimmable sub-controller
(4 x 5A max @ 12-36V)

AVAILABLE PSU OPTIONS

Control Mode	PSU (Order Code)	Input Voltage AC	Output Voltage DC	Rated Output Current	Rated Power	Dim %	IP Rating
Switched	CEN-60-24	90-295V	24V	2.5A	60W	-	IP67
	HLG-60H-24	90-305V	24V	2.5A	60W	-	IP67
	HLG-100H-24	90-305V	24V	4.0A	100W	-	IP67
	HLG-150H-24	90-305V	24V	6.3A	150W	-	IP67
	HLG-240H-24	90-305V	24V	10A	240W	-	IP67
0-10V (1-10V)	PWM-40-24	90-305V	24V	1.67A	40W	100-0.15 (100-10)	IP67
	PWM-60-24	90-305V	24V	2.5A	60W	100-0.15 (100-10)	IP67
	PWM-90-24	90-305V	24V	3.67A	90W	100-0.15 (100-10)	IP67
	PWM-120-24	90-305V	24V	5.0A	120W	100-0.15 (100-10)	IP67
DALI	LIN100A1	120-277V	24V	1A per channel	100W	100-0.1	IP66/IP40
DMX RGB	LIN100A1	120-277V	24V	1.33A per channel	100W	100-0.1	IP66/IP40
DMX RGBW	LIN100A1	120-277A	24V	1A per channel	100W	100-0.1	IP66/IP40

Flicker Free Options - Combination of PSU+ sub-controller

Control Mode	PSU (Order Code)	Sub-controller (Order Code)	Input Voltage AC	Output Voltage DC	Rated Output Current	Rated Power	Dim %	IP Rating PSU/ Sub-controller
0-10V or 1-10V	CEN-60-24	KKDM-06	90-295V	24V	2.5A	60W	100-0.9	IP67/IP20
	HLG-60H-24	KKDM-06	90-295V	24V	2.5A	60W	100-0.9	IP67/IP20
	HLG-100H-24	KKDM-06	90-295V	24V	4.0A	100W	100-0.9	IP67/IP20
	HLG-150H-24	KKDM-06	90-295V	24V	6.3A	150W	100-0.9	IP67/IP20
	HLG-240H-24	KKDM-06	90-295V	24V	10.0A	240W	100-0.9	IP67/IP20
DALI	CEN-60-24	KKDL-02/03/04/visDIM PRO 30	90-295V	24V	2.5A	60W	100-0.1	IP67/IP20
	HLG-60H-24	KKDL-02/03/04/visDIM PRO 30	90-305V	24V	2.5A	60W	100-0.1	IP67/IP20
	HLG-100H-24	KKDL-02/03/04/visDIM PRO 30	90-305V	24V	4.0A	100W	100-0.1	IP67/IP20
	HLG-150H-24	KKDL-02/03/04/visDIM PRO 30	90-305V	24V	6.3A	150W	100-0.1	IP67/IP20
	HLG-240H-24	KKDL-02/03/04/visDIM PRO 30	90-305V	24V	10.0A	240W	100-0.1	IP67/IP20
DMX RGB	CEN-60-24	KKSC-05	90-295V	24V	2.5A	60W	100-0.9	IP67/IP20
	HLG-60H-24	KKSC-05	90-305V	24V	2.5A	60W	100-0.9	IP67/IP20
	HLG-100H-24	KKSC-05	90-305V	24V	4A	100W	100-0.9	IP67/IP20
	HLG-150H-24	KKSC-05	90-305V	24V	6.3A	150W	100-0.9	IP67/IP20
	HLG-240H-24	KKSC-05	90-305V	24V	10.0A	240W	100-0.9	IP67/IP20

¹ The items shown above cover the most frequently used specification but does not exhaust the possible options

² PSU and/or driver can be chosen from the table, or KKDC may recommend the best option upon receipt of the controls requirement and installation environment

³ Electrical shop drawing will include detailed information of PSU and relevant control drivers

⁴ Cut sheets are available on the controls section of www.kkdc.lighting or upon request