

Linear

# MOMO Sauna R007 Fixture Guide

# KKDÖ

Indoor/Outdoor | Surface | Output up to 238lm/m (73lm/ft)

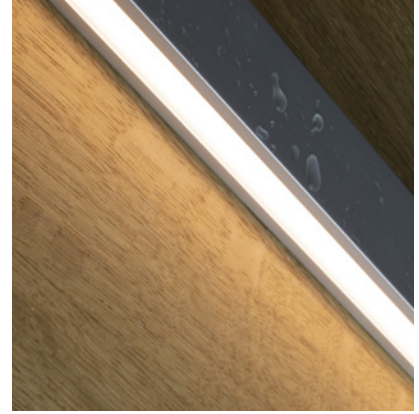
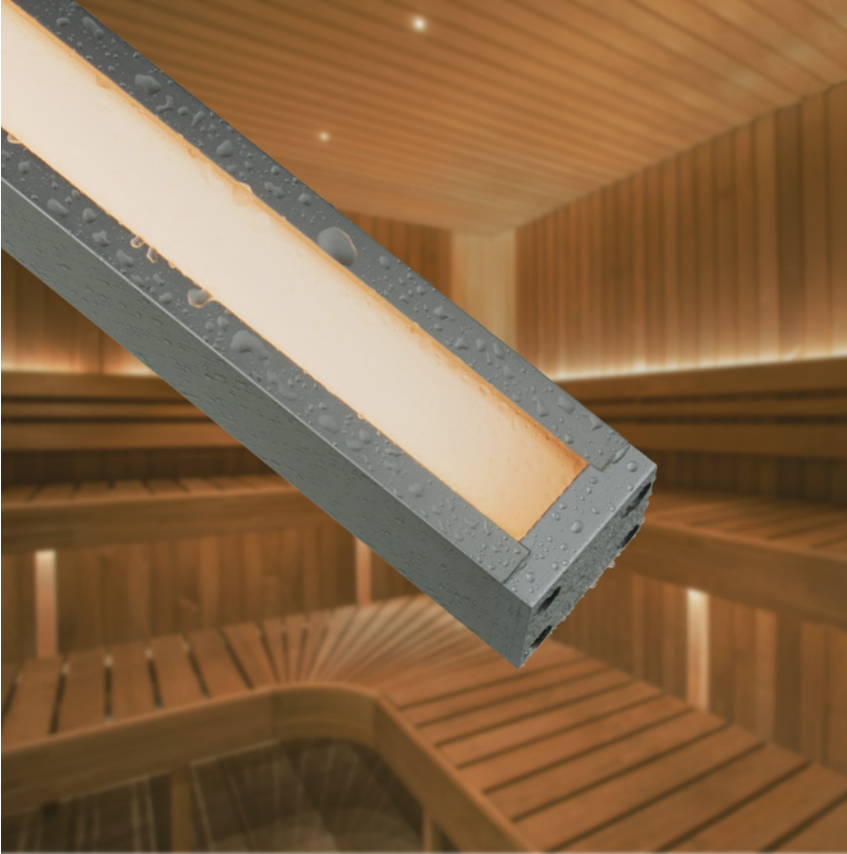

## Key applications

- ✓ Architectural detail
- ✓ Bathrooms
- ✓ Cabinet & furniture
- ✓ Cove lighting
- ✓ Direct lighting
- ✓ Exterior
- ✓ Interior
- ✓ Mirror back lighting
- ✓ Orientation lighting
- ✓ Sauna & steam room
- ✓ Uplighting
- ✓ Wet area

## Key features

- ✓ Adjustable
- ✓ Custom lengths
- ✓ Constant Voltage (CV)
- ✓ Diffusion: homogenous
- ✓ Direct view
- ✓ IP67 waterproof

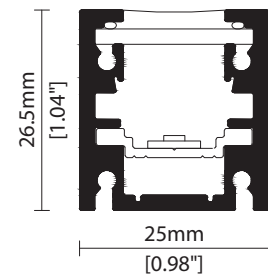

## MOUNTING METHODS



KKCP-03 Clip



KKCP-09 Lock clip



KKBK-07 Fixing plate



KKBK-21 Adjustable bracket

Linear

# MOMO Sauna R007

## Specification sheet



<b>Dimensions</b>	H26.5/W25/L113-2030mm (H1.04/W0.98/L4.44-79.92in)
<b>PCB Cut-point</b>	41.7mm increment/2000mm max (1.64in increment/78.74in max)
<b>LED Pitch</b>	6.95mm-144LED/m (0.27in - 44LED/ft)
<b>Chip</b>	<b>k-line</b>
<b>Cover/Optics</b>	Diffused (95°)
<b>CCT</b>	<b>k-line:</b> 2700K
<b>LED binning</b>	<b>k-line:</b> 3-step MacAdam ellipse
<b>CRI</b>	≥92
<b>Lifetime</b>	33,000 hours @ 100°C (33,000 hours @ 212°F)
<b>Operating temp</b>	Dry sauna; Ta=-25 to 100°C (T <sub>c</sub> max =105°C), RH 20% [US data] Steam room; Ta=-25 to 70°C (T <sub>c</sub> max =105°C), RH 100% [US data]
<b>IP Rating</b>	IP67
<b>Finish</b>	Silver anodised
<b>Mounting</b>	Surface mounting via clips or brackets
<b>Power feed</b>	Double sheathed tail
<b>Control</b>	0-10V/1-10V/DMX/DALI



### LED Grading Key

<b>Exclusive Grade</b>	
<b>s-line*</b> 2-step CCT range	*KKDC tuned CCT range
<b>Base Grade</b>	
<b>k-line</b> 3-step commercial range Energy Star CCTs	

<b>Power consumption</b>	<b>Supply voltage</b>	<b>Supply current</b>
7W/m (2.13W/ft)	24V DC	0.29A/m (0.09A/ft)

### Performance Data (3000K)

	R1	R2	R3	R4	R5	R6	R7	R8	R9	R10	R11	R12	R13	R14
<b>k-line</b>	93	97	98	90	92	94	91	83	63	91	90	75	94	98

	<b>Diffused</b>	<b>CRI</b>	<b>R9</b>	<b>Rf</b>	<b>Rg</b>
<b>k-line</b>	238lm/m (73lm/ft) 34lm/w	92	63	-	-

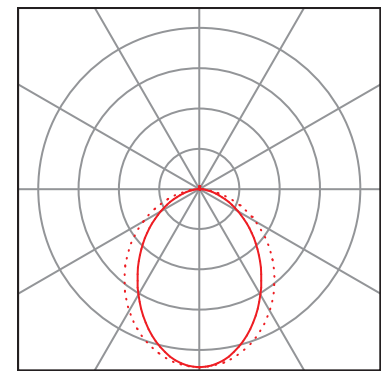
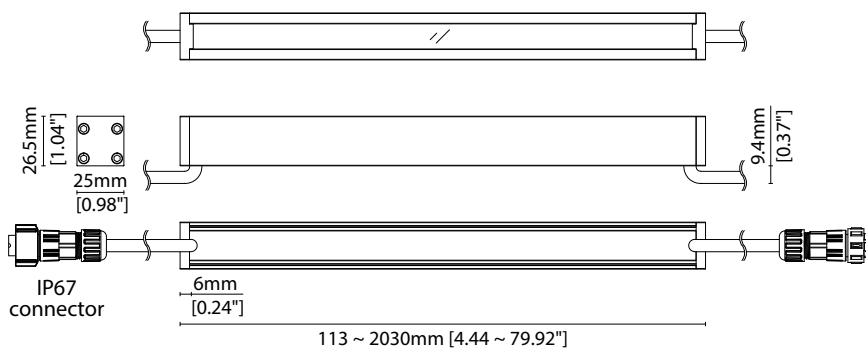

Data derived from independent UKAS/IESNA LM-79-08 accredited testing of production samples.

# MOMO Sauna R007

## Code Table



### FIXTURE

Model	Finish	Cover <sup>1</sup>	Grade <sup>2</sup>	LED	Colour (CCT)	Length Availability <sup>3</sup>	IP	Cable Length	Power Feed <sup>4</sup>	Input			
MOMO Sauna	MS	Silver Anodised SA	Diffused C	k	R007 R007	2700K 27 3000K 30 4000K 40	m	113-2030mm 78.74mm increments  4.44-79.92in 1.64in increments  (Specify length code OR total run length)	IP67 67	300mm/ 11.81"  0300	Single ø6.3mm sheath IP67 connector Double ø6.3mm sheath IP67 connector	S67B  D67B	DC 24V  g

<sup>1</sup> Refer to **Cover/Lens Options** on **Options** pages

<sup>2</sup> Refer to **LED Grading Key** on **Specification sheet** page

<sup>3</sup> Refer to **Length Availability List** or enter total run length instead of length code

<sup>4</sup> Refer to **Power feed Options** on **Options** pages

### Code Example:

MS	-	SA	-	C	-	k	-	R007	-	27	-	m	-	530	-	67	-	0300	-	D67B	-	g
MOMO Sauna		Silver Anodised		Diffused		k		R007		2700K		m		530mm		IP67		300mm/11.81"		Double ø6.3mm sheath IP67 connector		DC 24V

### ACCESSORIES

#### Mounting Accessories

KKCP-03	Clip (1no.)
KKCP-53	Clip (500no.)
KKCP-09	Lock Clip
KKBK-07	Fixing plate
KKBK-21	Adjustable bracket

\* Refer to **Mounting accessories** on **Accessories** pages

#### Connection Accessories

CN67-2P-0300	IP67 2 PIN male & female 300mm/11.81" pair
CN67-2P-1000	IP67 2 PIN male & female 1000mm/39.37" pair
CN67-2P-3000	IP67 2 PIN male & female 3000mm/118.11" pair

\* Refer to **Power feed** on **Accessories** pages

#### Exterior Junction Boxes

KKJB-07	IP67 Slim J-Box
KKJB-07R	Potting Resin for IP67 Slim J-Box

\* Refer to **Exterior Junction Boxes** on **Accessories** pages

#### PSU/Driver

0-10V/1-10V/DALI/DMX

\* Refer to **Driver/PSU Options** page for details or provide requirement and KKDC to offer the suitable option

### LED ENGINE VARIANTS (LED STRIP TYPE)

Colour	LED	Lumen/m	Lumen/ft	W/m	W/ft	Spec Doc	Length	Increment
Single CCT	R007	238	73	7.0	2.13	MOMO Sauna R007	113-2030mm (4.44-79.92in)	41.7mm (1.64in)
	A008	280	85	8.0	2.44	MOMO Sauna A008	107-2030mm (4.21-79.92in)	38.46mm (1.51in)

\* Performance data: A/k-line, diffused cover, 2700K

# MOMO Sauna R007

## Length Availability List



Length Code		Fixture Length <sup>1</sup>		LED Strip <sup>2</sup>		End Cap Dimension <sup>3</sup>		Wattage (W)	Output (lm)
Metric	Imperial(US)	Metric	Imperial(US)	Metric	Imperial(US)	Metric	Imperial(US)		3000K (Test Data)
m0113	i0004	113mm	4.46in	83mm	3.28in	10mm	0.39in	0.58	20
m0155	i0006	155mm	6.10in	125mm	4.92in	10mm	0.39in	0.87	30
m0197	i0008	197mm	7.74in	167mm	6.56in	10mm	0.39in	1.17	40
m0238	i0009	238mm	9.38in	208mm	8.20in	10mm	0.39in	1.46	50
m0280	i0011	280mm	11.02in	250mm	9.84in	10mm	0.39in	1.75	59
m0322	i0013	322mm	12.66in	292mm	11.48in	10mm	0.39in	2.04	69
m0363	i0014	363mm	14.30in	333mm	13.12in	10mm	0.39in	2.33	79
m0405	i0016	405mm	15.94in	375mm	14.76in	10mm	0.39in	2.62	89
m0447	i0018	447mm	17.59in	417mm	16.40in	10mm	0.39in	2.92	99
m0488	i0019	488mm	19.23in	458mm	18.04in	10mm	0.39in	3.21	109
m0530	i0021	530mm	20.87in	500mm	19.69in	10mm	0.39in	3.50	119
m0572	i0023	572mm	22.51in	542mm	21.33in	10mm	0.39in	3.79	129
m0613	i0024	613mm	24.15in	583mm	22.97in	10mm	0.39in	4.08	139
m0655	i0026	655mm	25.79in	625mm	24.61in	10mm	0.39in	4.37	149
m0697	i0027	697mm	27.43in	667mm	26.25in	10mm	0.39in	4.67	159
m0738	i0029	738mm	29.07in	708mm	27.89in	10mm	0.39in	4.96	169
m0780	i0031	780mm	30.71in	750mm	29.53in	10mm	0.39in	5.25	178
m0822	i0032	822mm	32.35in	792mm	31.17in	10mm	0.39in	5.54	188
m0863	i0034	863mm	33.99in	833mm	32.81in	10mm	0.39in	5.83	198
m0905	i0036	905mm	35.63in	875mm	34.45in	10mm	0.39in	6.12	208
m0947	i0037	947mm	37.27in	917mm	36.09in	10mm	0.39in	6.42	218
m0988	i0039	988mm	38.91in	958mm	37.73in	10mm	0.39in	6.71	228
m1030	i0041	1030mm	40.55in	1000mm	39.37in	10mm	0.39in	7.00	238
m1072	i0042	1072mm	42.19in	1042mm	41.01in	10mm	0.39in	7.29	248
m1113	i0044	1113mm	43.83in	1083mm	42.65in	10mm	0.39in	7.58	258
m1155	i0045	1155mm	45.47in	1125mm	44.29in	10mm	0.39in	7.87	268
m1197	i0047	1197mm	47.11in	1167mm	45.93in	10mm	0.39in	8.17	278
m1238	i0049	1238mm	48.75in	1208mm	47.57in	10mm	0.39in	8.46	288
m1280	i0050	1280mm	50.39in	1250mm	49.21in	10mm	0.39in	8.75	297
m1322	i0052	1322mm	52.03in	1292mm	50.85in	10mm	0.39in	9.04	307
m1363	i0054	1363mm	53.67in	1333mm	52.49in	10mm	0.39in	9.33	317
m1405	i0055	1405mm	55.31in	1375mm	54.13in	10mm	0.39in	9.62	327
m1447	i0057	1447mm	56.96in	1417mm	55.77in	10mm	0.39in	9.92	337
m1488	i0059	1488mm	58.60in	1458mm	57.41in	10mm	0.39in	10.21	347
m1530	i0060	1530mm	60.24in	1500mm	59.06in	10mm	0.39in	10.50	357
m1572	i0062	1572mm	61.88in	1542mm	60.70in	10mm	0.39in	10.79	367
m1613	i0064	1613mm	63.52in	1583mm	62.34in	10mm	0.39in	11.08	377
m1655	i0065	1655mm	65.16in	1625mm	63.98in	10mm	0.39in	11.37	387
m1697	i0067	1697mm	66.80in	1667mm	65.62in	10mm	0.39in	11.67	397
m1738	i0068	1738mm	68.44in	1708mm	67.26in	10mm	0.39in	11.96	407
m1780	i0070	1780mm	70.08in	1750mm	68.90in	10mm	0.39in	12.25	416
m1822	i0072	1822mm	71.72in	1792mm	70.54in	10mm	0.39in	12.54	426
m1863	i0073	1863mm	73.36in	1833mm	72.18in	10mm	0.39in	12.83	436

# MOMO Sauna R007

## Length Availability List



Length Code		Fixture Length <sup>1</sup>		LED Strip <sup>2</sup>		End Cap Dimension <sup>3</sup>		Wattage (W)	Output (lm)
Metric	Imperial(US)	Metric	Imperial(US)	Metric	Imperial(US)	Metric	Imperial(US)		3000K (Test Data)
m1905	i0075	1905mm	75.00in	1875mm	73.82in	10mm	0.39in	13.12	446
m1947	i0077	1947mm	76.64in	1917mm	75.46in	10mm	0.39in	13.42	456
m1988	i0078	1988mm	78.28in	1958mm	77.10in	10mm	0.39in	13.71	466
m2030	i0080	2030mm	79.92in	2000mm	78.74in	10mm	0.39in	14.00	476

<sup>1</sup> Actual total overall length of light fixture (LED strip + end caps + void/wire hole)

<sup>2</sup> Actual length of PCB strip

<sup>3</sup> Actual length of 2x end caps

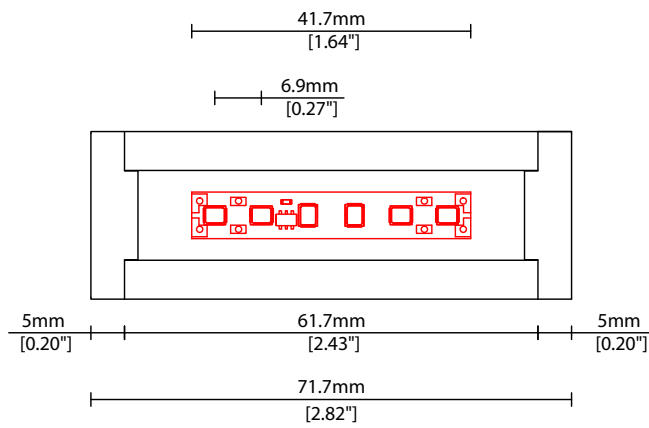



# MOMO Sauna R007 Options



## COVER/LENS OPTIONS

\* Options are an integral part of the fixture ordering codes. Please refer to **Code Table** pages.

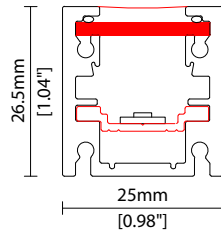

C Diffused Cover

### POWER FEED OPTIONS

0300 S67B 300mm (11.81") Single Ø6.3mm sheath IP67 connector

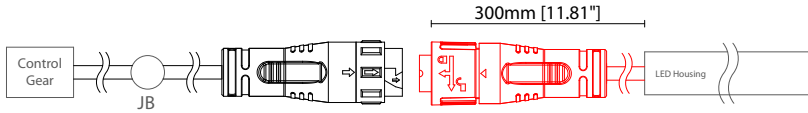

0300 D67B 300mm (11.81") Double Ø6.3mm sheath IP67 connector

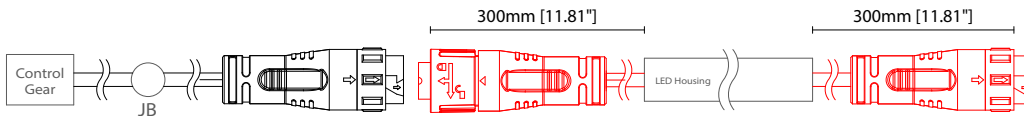

2 Pin Female Connector IP67 (Premoulded)

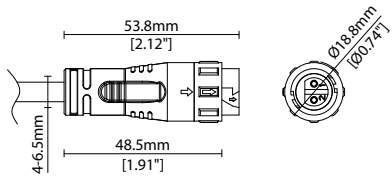

2 Pin Male Connector IP67 (Premoulded)

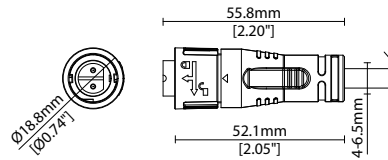

#### Key

- Control Gear Power supply, sub-controllers & control systems
- JB Junction box / cable connection

### MOUNTING ACCESSORIES

Note: Accessories are to be ordered separately with corresponding code shown below.



**KKCP-03** (1no.)  
**KKCP-53** (500no.)  
 Clip (allow 3 per metre/40in)  
 S/Steel finish  
 L25/W33.1/H29.4mm  
 (L0.98/W1.3/H1.16")

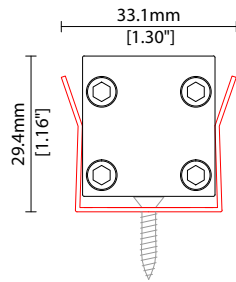

**KKCP-09**  
 Lock clip (allow 2 per metre/40in)  
 S/Steel finish  
 L25/W26.1/H33mm  
 (L0.98/W1.03/H1.3")

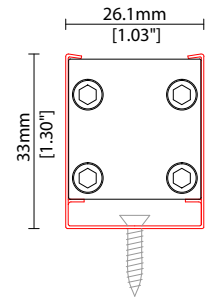

**KKBK-07**  
 Fixing plate (allow 2 per metre/40in)  
 Anodised aluminium finish  
 L50/W25/H34mm  
 (L1.97/W0.98/H1.34")  
 Pre-assembled in factory

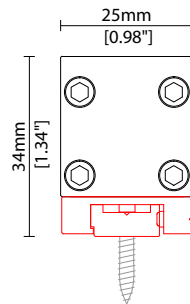

**KKBK-21**  
 Adjustable bracket  
 (allow 2 per metre/40in)  
 Anodised aluminium finish  
 L34/W25/H37.8mm  
 (L1.34/W0.98/H1.49")  
 Pre-assembled in factory

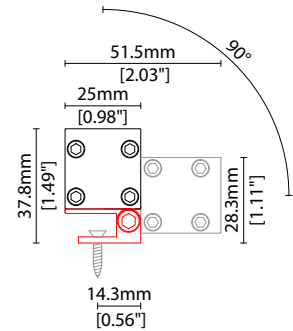

### POWER FEED

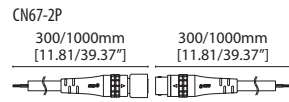

CN67-2P-0300 300mm (11.81in) pair  
 CN67-2P-1000 1000mm (39.37in) pair  
 IP67  
 2 PIN male + female connector set



CN67-2P-3000 3000mm (118.11in) pair  
 IP67  
 2 PIN male + female connector set

### EXTERIOR JUNCTION BOXES



KKJB-07  
 IP67 Slim J-Box  
 (including type A,B,C, D bushings)



KKJB-07R  
 Potting resin for IP67 Slim J-Box

### KKDC CONTROL



IP20  
Plastic housing  
L170/W59/H29mm  
(L6.69/W2.32/H1.14in)

#### KKDM-06 1-10V

visDIM dimmable sub-controller  
(4 x 8A max @ 12-36V)



IP20  
Plastic housing  
L170/W53.4/H28mm  
(L6.69/W2.10/H1.10in)

#### KKSC-05 DMX

visDIM dimmable sub-controller  
(4 x 5A max @ 12-36V)



IP20  
Plastic housing  
L170/W59/H29mm  
(L6.69/W2.32/H1.14in)

#### KKDL-02 DALI

visDIM dimmable sub-controller  
(4 x 8A max @ 12-36V)



IP20  
Plastic housing  
L166/W53.4/H23mm  
(L6.54/W2.10/H0.91in)

#### KKDL-03 DALI

visDIM dimmable sub-controller  
(4 x 5A max @ 12-36V)



IP20  
Plastic housing  
L170/W53.4/H28mm  
(L6.69/W2.10/H1.10in)

#### KKDL-04 DALI-2

visDIM dimmable sub-controller  
(4 x 5A max @ 12-36V)

### AVAILABLE PSU OPTIONS

Control Mode	PSU (Order Code)	Input Voltage AC	Output Voltage DC	Rated Output Current	Rated Power	Dim %	IP Rating
Switched	CEN-60-24	90-295V	24V	2.5A	60W	-	IP67
	HLG-60H-24	90-305V	24V	2.5A	60W	-	IP67
	HLG-100H-24	90-305V	24V	4.0A	100W	-	IP67
	HLG-150H-24	90-305V	24V	6.3A	150W	-	IP67
	HLG-240H-24	90-305V	24V	10A	240W	-	IP67
0-10V (1-10V)	PWM-40-24	90-305V	24V	1.67A	40W	100-0.15 (100-10)	IP67
	PWM-60-24	90-305V	24V	2.5A	60W	100-0.15 (100-10)	IP67
	PWM-90-24	90-305V	24V	3.67A	90W	100-0.15 (100-10)	IP67
	PWM-120-24	90-305V	24V	5.0A	120W	100-0.15 (100-10)	IP67
DALI	LIN100A1	120-277V	24V	1A per channel	100W	100-0.1	IP66/IP40
DMX RGB	LIN100A1	120-277V	24V	1.33A per channel	100W	100-0.1	IP66/IP40
DMX RGBW	LIN100A1	120-277A	24V	1A per channel	100W	100-0.1	IP66/IP40

### Flicker Free Options - Combination of PSU+ sub-controller

Control Mode	PSU (Order Code)	Sub-controller (Order Code)	Input Voltage AC	Output Voltage DC	Rated Output Current	Rated Power	Dim %	IP Rating PSU/ Sub-controller
0-10V or 1-10V	CEN-60-24	KKDM-06	90-295V	24V	2.5A	60W	100-0.9	IP67/IP20
	HLG-60H-24	KKDM-06	90-295V	24V	2.5A	60W	100-0.9	IP67/IP20
	HLG-100H-24	KKDM-06	90-295V	24V	4.0A	100W	100-0.9	IP67/IP20
	HLG-150H-24	KKDM-06	90-295V	24V	6.3A	150W	100-0.9	IP67/IP20
	HLG-240H-24	KKDM-06	90-295V	24V	10.0A	240W	100-0.9	IP67/IP20
DALI	CEN-60-24	KKDL-02/03/04/visDIM PRO 30	90-295V	24V	2.5A	60W	100-0.1	IP67/IP20
	HLG-60H-24	KKDL-02/03/04/visDIM PRO 30	90-305V	24V	2.5A	60W	100-0.1	IP67/IP20
	HLG-100H-24	KKDL-02/03/04/visDIM PRO 30	90-305V	24V	4.0A	100W	100-0.1	IP67/IP20
	HLG-150H-24	KKDL-02/03/04/visDIM PRO 30	90-305V	24V	6.3A	150W	100-0.1	IP67/IP20
	HLG-240H-24	KKDL-02/03/04/visDIM PRO 30	90-305V	24V	10.0A	240W	100-0.1	IP67/IP20
DMX RGB	CEN-60-24	KKSC-05	90-295V	24V	2.5A	60W	100-0.9	IP67/IP20
	HLG-60H-24	KKSC-05	90-305V	24V	2.5A	60W	100-0.9	IP67/IP20
	HLG-100H-24	KKSC-05	90-305V	24V	4A	100W	100-0.9	IP67/IP20
	HLG-150H-24	KKSC-05	90-305V	24V	6.3A	150W	100-0.9	IP67/IP20
	HLG-240H-24	KKSC-05	90-305V	24V	10.0A	240W	100-0.9	IP67/IP20

<sup>1</sup> The items shown above cover the most frequently used specification but does not exhaust the possible options

<sup>2</sup> PSU and/or driver can be chosen from the table, or KKDC may recommend the best option upon receipt of the controls requirement and installation environment

<sup>3</sup> Electrical shop drawing will include detailed information of PSU and relevant control drivers

<sup>4</sup> Cut sheets are available on the controls section of [www.kkdc.lighting](http://www.kkdc.lighting) or upon request