

Linear

LINI-R R007

Fixture Guide

KKDC

Indoor | Recessed | Output up to 230lm/m (70lm/ft)



Key applications

- ✓ Ceiling
- ✓ Downlighting
- ✓ Direct lighting
- ✓ Interior

Key features

- ✓ Custom lengths
- ✓ Constant Voltage (CV)
- ✓ Diffusion: homogenous
- ✓ Extensive CCT range
- ✓ IP40 dry area
- ✓ IP44 moisture resistant

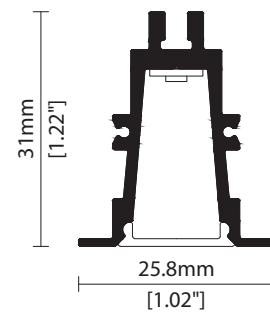

Linear

LINI-R R007

Specification sheet



Dimensions	H31/W25.8/L100-2017mm (H1.22/W1.02/L3.93-79.41in) (excluding spring clips)
PCB Cut-point	41.7mm increment/2000mm max (1.64in increment/78.74in max)
LED Pitch	6.95mm-144LED/m (0.27in - 44LED/ft)
Chip	s-line k-line
Cover/Optics	Diffused (110°)
CCT	s-line: 1900K/2100K/2300K/2500K/2700K/3000K/3500K/4000K/5000K Single colours: Red/Green/Blue/Orange/Amber k-line: 1900K/2100K/2300K/2500K/2700K/3000K/3500K/4000K/5000K
LED binning	s-line: 2-step MacAdam ellipse k-line: 3-step MacAdam ellipse
CRI	≥93
Lifetime	50,000 hours @ 25°C (50,000 hours @ 77°F)
Operating temp	T _a = -25 to 50°C (T _c max = 54°C) T _a = -13 to 122°F (T _c max = 130°F)
IP Rating	IP40/IP44
Finish	Silver anodised
Mounting	Recessed mounting via spring clip
Power feed	Hardwire tails or male/female connectors
Control	0-10V/1-10V/DMX/DALI

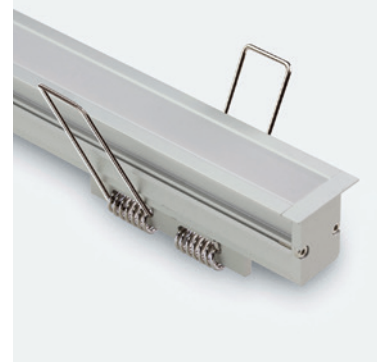

LED Grading Key

Exclusive Grade

s-line*
2-step CCT range

*KKDC tuned
CCT range

Base Grade

k-line
3-step commercial range
Energy Star CCTs

Power consumption	Supply voltage	Supply current
7W/m (2.13W/ft)	24V DC	0.29A/m (0.09A/ft)

Performance Data (3000K)

	R1	R2	R3	R4	R5	R6	R7	R8	R9	R10	R11	R12	R13	R14
k-line	93	97	98	91	92	94	92	84	66	92	91	74	95	98

Diffused Cover

s-line	230lm/m (70lm/ft)																	
	32.9lm/W																	
k-line	217lm/m (66lm/ft)																	
	31lm/W																	

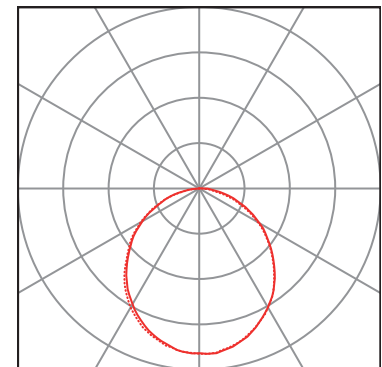
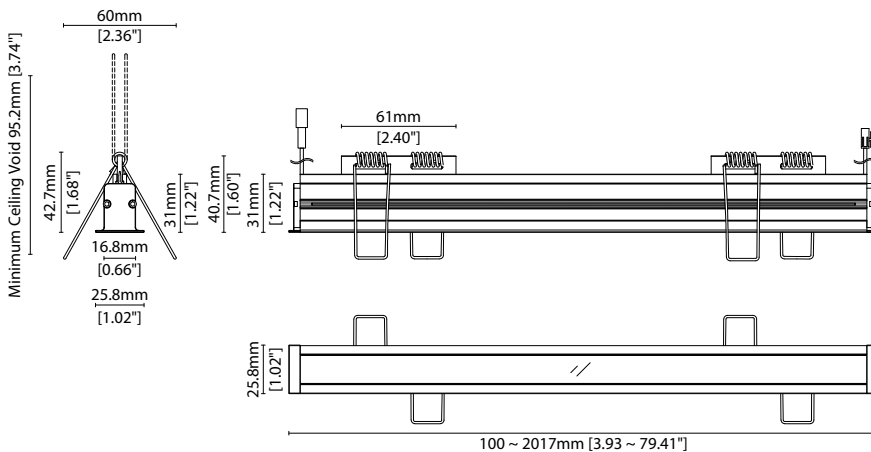

— C0 / C180 cd / 1000 lm - - - C90 / C270

Data derived from independent UKAS / IESNA LM-79-08 accredited testing of production samples.

FIXTURE

Model	Finish	Cover ¹	Grade ²	LED	Colour (CCT)	Length Availability ³	IP	Cable Length	Power Feed ⁴	Input					
LINI-R LR	Silver Anodised SA	Diffused C	s- s k- k	R007 R007	1900K 19	m 100.3-2017mm 83.3mm increments	IP40 40 IP44 44	50mm/1.97" 0050 300mm/11.81" 0300 1000mm/39.37" 1000	Single no sheath tail S00X Double no sheath tail D00X Single no sheath IP20 connector S20X Double no sheath IP20 connector D20X	DC 24V g					
					2100K 21										
					2300K 23										
					2500K 25	i 3.95-79.41in 3.28in increments (Specify length code OR total run length)	IP40 40 IP44 44	50mm/1.97" 0050 300mm/11.81" 0300 1000mm/39.37" 1000	Single no sheath IP20 connector S20X Double no sheath IP20 connector D20X						
					2700K 27										
					3000K 30										
					3500K 35										
					4000K 40										
					5000K 50										
					RED RED s- only	i 3.95-79.41in 3.28in increments (Specify length code OR total run length)	IP40 40 IP44 44	50mm/1.97" 0050 300mm/11.81" 0300 1000mm/39.37" 1000	Single no sheath IP20 connector S20X Double no sheath IP20 connector D20X						
					GREEN GRN										
					BLUE BLU										
					ORANGE ORN										
					AMBER AMB										

¹ Refer to **Cover/Lens options** on **Options** page

² Refer to **LED Grading Key** on **Specification sheet** page

³ Refer to **Length Availability List** or enter total run length instead of length code

⁴ Refer to **Power Feed Options** on **Options** pages

Code Example:

LR	-	SA	-	C	-	s	-	R007	-	35	-	m	517	-	40	-	0300	-	D00X	-	g
LINI-R		Silver Anodised		Diffused		s-		R007		3500K		517mm		IP40		300mm/11.81"		Double no sheath tail		DC 24V	

ACCESSORIES

Connection Accessories

KKCN-01	2 PIN male & female 50mm/1.97" pair
KKCN-03	2 PIN male & female 300mm/11.81" pair
KKCN-06	2 PIN 300mm/11.81" extension lead

PSU/Driver

0-10V/1-10V/DALI/DMX

* Refer to **Driver/PSU Options** page for details or provide requirement and KKDC to offer the suitable option

* Refer to **Power feed** on **Accessories** pages

LED ENGINE VARIANTS (LED STRIP TYPE)

Colour	LED	Lumen/m	Lumen/ft	W/m	W/ft	Spec Doc	Length	Increment
Single CCT	R007	230	70	7	2.13	LINI-R R007	100-2017mm (3.93-79.41in)	41.7mm (1.64in)
Warm Dim/Dynamic White	R014	475	145	14	4.27	LINI-R R014	100-2017mm (3.93-79.41in)	41.7mm (1.64in)
	R020	678	207	20	6.10	LINI-R R020	100-2017mm (3.93-79.41in)	41.7mm (1.64in)
	R207	546	166	16	6.10	LINI-R R207	100-2017mm (3.93-79.41in)	83.3mm (3.28in)
RGB	501	Red: 54 Green: 116 Blue: 19 RGB: 167	Red: 16 Green: 35 Blue: 6 RGB: 51	15.6	4.75	LINI-R RGB	100-2017mm (3.93-79.41in)	83.3mm (3.28in)

* Performance data: s-line, 3000K, diffused cover

LINE-R R007

Length Availability List



Length Code		Fixture Length ¹		LED Strip ²		End Cap Dimension		Wattage (W)	Output (lm)
Metric	Imperial(US)	Metric	Imperial(US)	Metric	Imperial(US)	Metric	Imperial(US)		3000K (Test Data)
m0100	i0004	100mm	3.95in	83mm	3.28in	12mm	0.47in	0.58	18
m0142	i0006	142mm	5.59in	125mm	4.92in	12mm	0.47in	0.87	27
m0184	i0007	184mm	7.23in	167mm	6.56in	12mm	0.47in	1.17	36
m0225	i0009	225mm	8.87in	208mm	8.20in	12mm	0.47in	1.46	45
m0267	i0011	267mm	10.51in	250mm	9.84in	12mm	0.47in	1.75	54
m0309	i0012	309mm	12.15in	292mm	11.48in	12mm	0.47in	2.04	63
m0350	i0014	350mm	13.79in	333mm	13.12in	12mm	0.47in	2.33	72
m0392	i0015	392mm	15.43in	375mm	14.76in	12mm	0.47in	2.62	81
m0434	i0017	434mm	17.07in	417mm	16.40in	12mm	0.47in	2.92	90
m0475	i0019	475mm	18.71in	458mm	18.04in	12mm	0.47in	3.21	99
m0517	i0020	517mm	20.35in	500mm	19.69in	12mm	0.47in	3.50	108
m0559	i0022	559mm	21.99in	542mm	21.33in	12mm	0.47in	3.79	118
m0600	i0024	600mm	23.64in	583mm	22.97in	12mm	0.47in	4.08	127
m0642	i0025	642mm	25.28in	625mm	24.61in	12mm	0.47in	4.37	136
m0684	i0027	684mm	26.92in	667mm	26.25in	12mm	0.47in	4.67	145
m0725	i0029	725mm	28.56in	708mm	27.89in	12mm	0.47in	4.96	154
m0767	i0030	767mm	30.20in	750mm	29.53in	12mm	0.47in	5.25	163
m0809	i0032	809mm	31.84in	792mm	31.17in	12mm	0.47in	5.54	172
m0850	i0033	850mm	33.48in	833mm	32.81in	12mm	0.47in	5.83	181
m0892	i0035	892mm	35.12in	875mm	34.45in	12mm	0.47in	6.12	190
m0934	i0037	934mm	36.76in	917mm	36.09in	12mm	0.47in	6.42	199
m0975	i0038	975mm	38.40in	958mm	37.73in	12mm	0.47in	6.71	208
m1017	i0040	1017mm	40.04in	1000mm	39.37in	12mm	0.47in	7.00	217
m1059	i0042	1059mm	41.68in	1042mm	41.01in	12mm	0.47in	7.29	226
m1100	i0043	1100mm	43.32in	1083mm	42.65in	12mm	0.47in	7.58	235
m1142	i0045	1142mm	44.96in	1125mm	44.29in	12mm	0.47in	7.87	244
m1184	i0047	1184mm	46.60in	1167mm	45.93in	12mm	0.47in	8.17	253
m1225	i0048	1225mm	48.24in	1208mm	47.57in	12mm	0.47in	8.46	262
m1267	i0050	1267mm	49.88in	1250mm	49.21in	12mm	0.47in	8.75	271
m1309	i0052	1309mm	51.52in	1292mm	50.85in	12mm	0.47in	9.04	280
m1350	i0053	1350mm	53.16in	1333mm	52.49in	12mm	0.47in	9.33	289
m1392	i0055	1392mm	54.80in	1375mm	54.13in	12mm	0.47in	9.62	298
m1434	i0056	1434mm	56.44in	1417mm	55.77in	12mm	0.47in	9.92	307
m1475	i0058	1475mm	58.08in	1458mm	57.41in	12mm	0.47in	10.21	316
m1517	i0060	1517mm	59.72in	1500mm	59.06in	12mm	0.47in	10.50	325
m1559	i0061	1559mm	61.36in	1542mm	60.70in	12mm	0.47in	10.79	335
m1600	i0063	1600mm	63.01in	1583mm	62.34in	12mm	0.47in	11.08	344
m1642	i0065	1642mm	64.65in	1625mm	63.98in	12mm	0.47in	11.37	353
m1684	i0066	1684mm	66.29in	1667mm	65.62in	12mm	0.47in	11.67	362
m1725	i0068	1725mm	67.93in	1708mm	67.26in	12mm	0.47in	11.96	371
m1767	i0070	1767mm	69.57in	1750mm	68.90in	12mm	0.47in	12.25	380
m1809	i0071	1809mm	71.21in	1792mm	70.54in	12mm	0.47in	12.54	389
m1850	i0073	1850mm	72.85in	1833mm	72.18in	12mm	0.47in	12.83	398

LINE-R R007

Length Availability List



Length Code		Fixture Length ¹		LED Strip ²		End Cap Dimension		Wattage (W)	Output (lm) 3000K (Test Data)
Metric	Imperial(US)	Metric	Imperial(US)	Metric	Imperial(US)	Metric	Imperial(US)		
m1892	i0074	1892mm	74.49in	1875mm	73.82in	12mm	0.47in	13.12	407
m1934	i0076	1934mm	76.13in	1917mm	75.46in	12mm	0.47in	13.42	416
m1975	i0078	1975mm	77.77in	1958mm	77.10in	12mm	0.47in	13.71	425
m2017	i0079	2017mm	79.41in	2000mm	78.74in	12mm	0.47in	14.00	434

¹ Actual total overall length of light fixture (LED strip + end caps + void/wire hole)

² Actual length of PCB strip

³ Actual length of 2x end caps

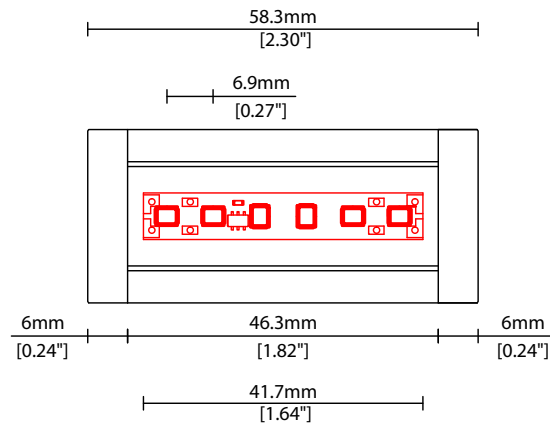



LINI-R R007

Options



COVER/LENS OPTIONS

* Options are an integral part of the fixture ordering codes. Please refer to **Code Table** pages.

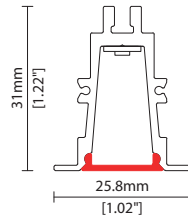

C Diffused cover
W25.8/H31mm (W1.02/H1.22")

POWER FEED OPTIONS

* Options are an integral part of the fixture ordering codes. Please refer to **Code Table** pages.

0050 S20X 50mm (1.97") Single no sheath IP20 connector

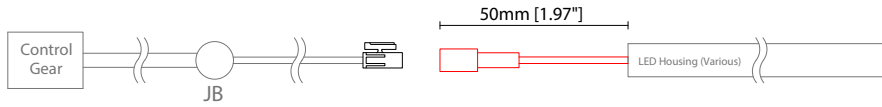

0050 D20X 50mm (1.97") Double no sheath IP20 connector

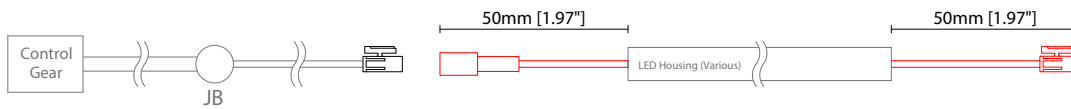

0300 S00X 300mm (11.81") Single no sheath tail

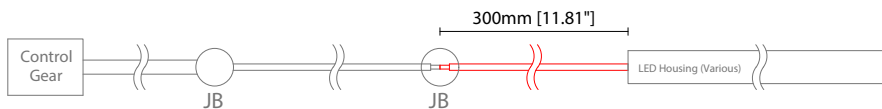

0300 D00X 300mm (11.81") Double no sheath tail

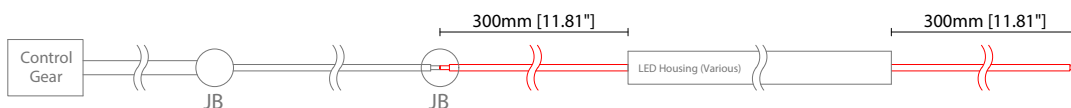

0300 S20X 300mm (11.81") Single no sheath IP20 connector

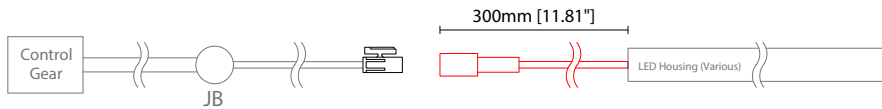

0300 D20X 300mm (11.81") Double no sheath IP20 connector

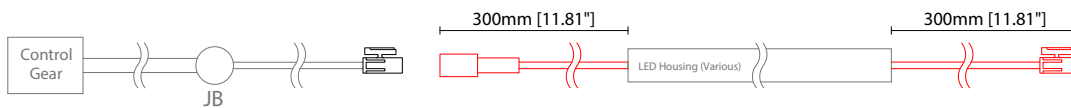

1000 S00X 1000mm (39.37") Single no sheath tail

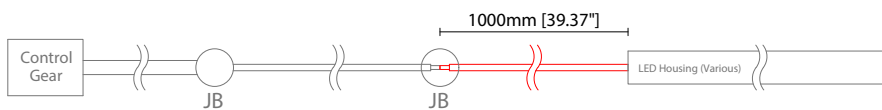

1000 D00X 1000mm (39.37") Double no sheath tail

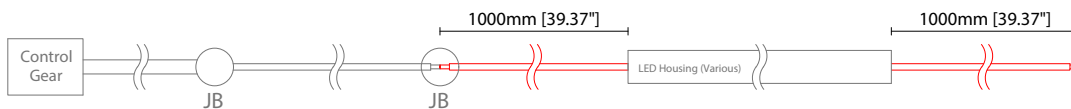

1000 S20X 1000mm (39.37") Single no sheath IP20 connector

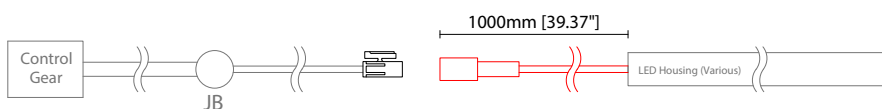

Key

Control Gear Power supply, sub-controllers & control systems

JB Junction box / cable connection

POWER FEED OPTIONS (CONTINUED)

1000 D20X 1000mm (39.37") Double no sheath IP20 connector

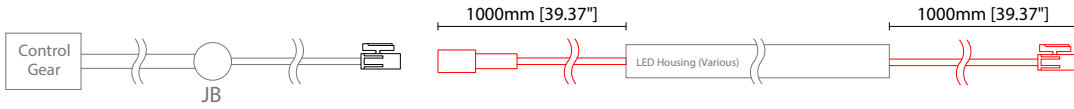

2 Pin Female Connector

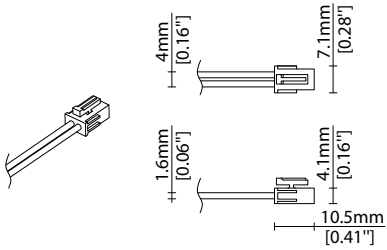

2 Pin Male Connector

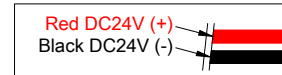
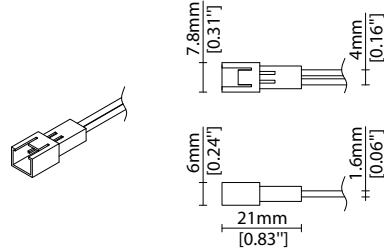

Key

Control Gear Power supply, sub-controllers & control systems
 JB Junction box / cable connection

POWER FEED

Note: Accessories are to be ordered separately with corresponding code shown below.

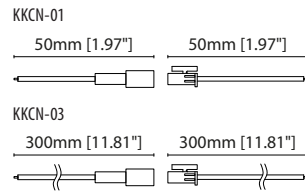
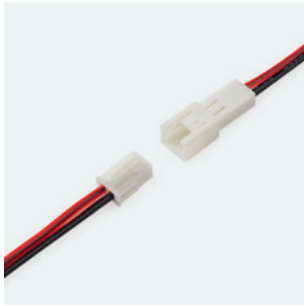

KKCN-01 50mm (1.97in) pair
KKCN-03 300mm (11.81in) pair
2 PIN male + female connector set

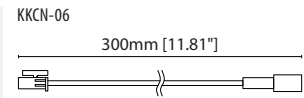

KKCN-06
2 PIN 300mm (11.81in) extension
lead

KKDC CONTROL



IP20
Plastic housing
L170/W59/H29mm
(L6.69/W2.32/H1.14in)

KKDM-06 1-10V

visDIM dimmable sub-controller
(4 x 8A max @ 12-36V)



IP20
Plastic housing
L170/W53.4/H28mm
(L6.69/W2.10/H1.10in)

KKSC-05 DMX

visDIM dimmable sub-controller
(4 x 5A max @ 12-36V)



IP20
Plastic housing
L170/W59/H29mm
(L6.69/W2.32/H1.14in)

KKDL-02 DALI

visDIM dimmable sub-controller
(4 x 8A max @ 12-36V)



IP20
Plastic housing
L166/W53.4/H23mm
(L6.54/W2.10/H0.91in)

KKDL-03 DALI

visDIM dimmable sub-controller
(4 x 5A max @ 12-36V)



IP20
Plastic housing
L170/W53.4/H28mm
(L6.69/W2.10/H1.10in)

KKDL-04 DALI-2

visDIM dimmable sub-controller
(4 x 5A max @ 12-36V)

AVAILABLE PSU OPTIONS

Control Mode	PSU (Order Code)	Input Voltage AC	Output Voltage DC	Rated Output Current	Rated Power	Dim %	IP Rating
Switched	CEN-60-24	90-295V	24V	2.5A	60W	-	IP67
	HLG-60H-24	90-305V	24V	2.5A	60W	-	IP67
	HLG-100H-24	90-305V	24V	4.0A	100W	-	IP67
	HLG-150H-24	90-305V	24V	6.3A	150W	-	IP67
	HLG-240H-24	90-305V	24V	10A	240W	-	IP67
0-10V (1-10V)	PWM-40-24	90-305V	24V	1.67A	40W	100-0.15 (100-10)	IP67
	PWM-60-24	90-305V	24V	2.5A	60W	100-0.15 (100-10)	IP67
	PWM-90-24	90-305V	24V	3.67A	90W	100-0.15 (100-10)	IP67
	PWM-120-24	90-305V	24V	5.0A	120W	100-0.15 (100-10)	IP67
DALI	LIN100A1	120-277V	24V	1A per channel	100W	100-0.1	IP66/IP40
DMX RGB	LIN100A1	120-277V	24V	1.33A per channel	100W	100-0.1	IP66/IP40
DMX RGBW	LIN100A1	120-277A	24V	1A per channel	100W	100-0.1	IP66/IP40

Flicker Free Options - Combination of PSU+ sub-controller

Control Mode	PSU (Order Code)	Sub-controller (Order Code)	Input Voltage AC	Output Voltage DC	Rated Output Current	Rated Power	Dim %	IP Rating PSU/ Sub-controller
0-10V or 1-10V	CEN-60-24	KKDM-06	90-295V	24V	2.5A	60W	100-0.9	IP67/IP20
	HLG-60H-24	KKDM-06	90-295V	24V	2.5A	60W	100-0.9	IP67/IP20
	HLG-100H-24	KKDM-06	90-295V	24V	4.0A	100W	100-0.9	IP67/IP20
	HLG-150H-24	KKDM-06	90-295V	24V	6.3A	150W	100-0.9	IP67/IP20
	HLG-240H-24	KKDM-06	90-295V	24V	10.0A	240W	100-0.9	IP67/IP20
DALI	CEN-60-24	KKDL-02/03/04/visDIM PRO 30	90-295V	24V	2.5A	60W	100-0.1	IP67/IP20
	HLG-60H-24	KKDL-02/03/04/visDIM PRO 30	90-305V	24V	2.5A	60W	100-0.1	IP67/IP20
	HLG-100H-24	KKDL-02/03/04/visDIM PRO 30	90-305V	24V	4.0A	100W	100-0.1	IP67/IP20
	HLG-150H-24	KKDL-02/03/04/visDIM PRO 30	90-305V	24V	6.3A	150W	100-0.1	IP67/IP20
	HLG-240H-24	KKDL-02/03/04/visDIM PRO 30	90-305V	24V	10.0A	240W	100-0.1	IP67/IP20
DMX RGB	CEN-60-24	KKSC-05	90-295V	24V	2.5A	60W	100-0.9	IP67/IP20
	HLG-60H-24	KKSC-05	90-305V	24V	2.5A	60W	100-0.9	IP67/IP20
	HLG-100H-24	KKSC-05	90-305V	24V	4A	100W	100-0.9	IP67/IP20
	HLG-150H-24	KKSC-05	90-305V	24V	6.3A	150W	100-0.9	IP67/IP20
	HLG-240H-24	KKSC-05	90-305V	24V	10.0A	240W	100-0.9	IP67/IP20

¹ The items shown above cover the most frequently used specification but does not exhaust the possible options

² PSU and/or driver can be chosen from the table, or KKDC may recommend the best option upon receipt of the controls requirement and installation environment

³ Electrical shop drawing will include detailed information of PSU and relevant control drivers

⁴ Cut sheets are available on the controls section of www.kkdc.lighting or upon request